



Cristófoli, Brazilian importing company and manufacturer of health products.

Cristófoli Distiller

CRISTÓFOLI'S MISSION

Develop innovative solutions to protect life and promote health.

CRISTÓFOLI'S QUALITY AND ENVIRONMENTAL POLICY













Cristófoli Equipamentos de Biossegurança Ltda., established at Rua São José, 3209, Área Urbanizada II in Campo Mourão, Paraná, Brasil, manufactures biosafety equipment to assist the health field having as policy: "Develop innovative solutions for the health field by using agile, robust and objective processes to better serve its clients. Fulfill the requirements for regulatory purposes of the applicable standards, promote the continuous improvement of its quality and environmental systems, prevent pollution, reduce its environmental impacts and continuous training of its employees, achieving this way, a sustainable profitability and the maximization of the company's value". Rev. 2.

*BPF - Boas Práticas de Fabricação:
Brazilian standard similar to the GMP - Good Manufacturing Practices (FDA / US).

TABLE OF CONTENTS

Legend of Symbols	03
Intended Use	04
Contents of the Box	04
Recommendations and Warnings	04
Installation Instructions	05
Safety Devices	06
Components Identification	06
How to Use the Cristófoli Distiller	07
Distilled Water for Human Consumption	08
Water for steam sterilization	08
Distilled Water Shelf Life and Storage	09
How to Identify your Distiller	09
Technical Data	09
Preventive Maintenance	10
Troubleshooting	11
Quality control	11
Authorized Technical Assistance	12
Guidance for Final Disposal of the Equipment	12
Warranty Terms	13

LEGEND OF SYMBOLS

	Caution, consult accompanying documents		Keep out of sunlight
	Alternating Current		Fragile Handle with Care
	This Side Up		Lot Number
	Date of Manufacture		Serial Number
	Manufacturer		Recyclable
	Maximum Pile		Keep Dry

INTENDED USE

This equipment was developed to distill water to be used in steam sterilization autoclaves.

CONTENTS OF THE BOX

Items included in the product box:

- 1 Cristófoli Distiller;
- 1 metal clip;
- 1 cap for the distilled water container;
- 1 heating element filter;
- 3 activated carbon filters;
- 1 instruction manual.

RECOMMENDATIONS AND WARNINGS

- ▶ Read all the instructions in this manual before using your distiller. Incorrect use may result in damage to the equipment and/or accidents.
- ▶ The equipment must be handled by qualified and well-informed personnel, regarding its features and functioning.
- ▶ For your safety, when performing any kind of maintenance, remember to unplug the equipment and use PPE (Personal Protective Equipment).
- ▶ Make sure all the air openings for ventilation on the top of the distiller and on its sides are not obstructed.
- ▶ As a routine, make sure all the distiller components are properly fitted before using it. Non-observance of this procedure may interfere in its correct functioning. See "How to Use the *Cristófoli Distiller*" (Page 7).
- ▶ **Never** remove the main unit or touch the water tray while the distiller is on;

IMPORTER

Cristófoli Equipamentos de Biossegurança Ltda.
Rua São José, 3209 - Campo Mourão - PR - Brasil
CEP 87307-799
CNPJ 01.177.248/0001-95 - Inscr. Est. 90104860-65
www.cristofoli.com - e-mail: cristofoli@cristofoli.com

Responsible Technician
Eduardo Luiz Soppa
CREA-PR: 109201/D

INSTALLATION INSTRUCTIONS

The storage must be done in a place protected from the weather action (indoors) in normal temperature conditions

Install the distiller in an exclusive sterilization room, ventilated and clean, on a flat, leveled and firm surface, at a proper height for the operator to handle it. Leave enough room next to the distiller for handling the water containers.

ELECTRICAL

See "Authorized Technical Assistance" (Page 12). In case the user chooses an unauthorized electrician or technician to install the equipment, Cristófoli Biossegurança will not be responsible for any services performed in disagreement with the instructions described in the product manual.

- 1▶ The voltage of the distiller is 127 V **or** 220 V, as informed on the identification label located on the bottom of the equipment. Make sure the wiring **voltage** where the equipment will be installed is in accordance with these values.
- 2▶ For the installation, use a three pin outlet with grounding pin (2P + T, 10A).
- 3▶ **Never** use extensions, adapters or voltage transformers.

ATTENTION! Grounding is very important for the safety of the operator and the warranty of your equipment. Install the distiller where it can be easily unplugged.

The electrical installation must follow the data from the table below.

MODEL	AMPERAGE	WIRING GAUGE (DIAMETER)
Cristófoli Distiller (127 V)	4,3 A	The wiring from the breaker to the electrical outlet used to connect the equipment must have a diameter of at least 2.5 mm.
Cristófoli Distiller (220 V)	2,2 A	

Table 1

INSTALLATION OF THE HEATING ELEMENT FILTER

The filter is designed to minimize the buildup of scale (mineral deposits) on the heating element during the distillation process. Most of the residues are retained by the filter, which can be washed and reused. This ensures maximum heating efficiency and performance of the distiller. See "Preventive Maintenance" (Page 10).

- A. Remove the filter from the plastic packaging and soak it in water until it is completely saturated.
- B. Remove the main unit and turn it upside down so that the heating element faces upward (Fig. 1).
- C. Insert the filter into the heating element housing (Figures 1 and 2) and use the supplied metal clip to secure it (Fig. 3).
- D. Return the main unit to its original position.

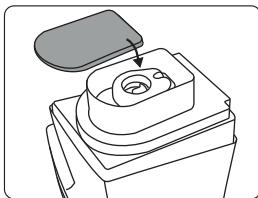

Fig. 1

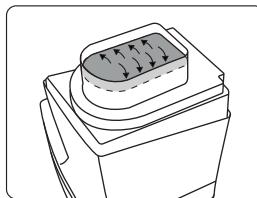

Fig. 2

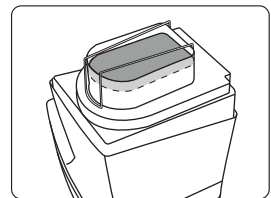

Fig. 3

SAFETY DEVICES

- ▶ **THERMOSTAT** - Internal device of the equipment, its function is to prevent an overheating of the heating element.
- ▶ **THERMAL FUSE** - Internal safety device that cuts the electrical current of the equipment, in case the thermostat malfunction. There are two thermal fuses, one attached to the heating element and another in the cooler motor.
- ▶ **WATER LEVEL SWITCH** - Device (Fig. 5, page 7) which function is to turn the equipment off in the following cases:
 - A. If the tap water container is removed, tilted or raised.
 - B. At the end of the distillation cycle.

Note.: All components in direct contact with the water are non-toxic.

COMPONENTS IDENTIFICATION

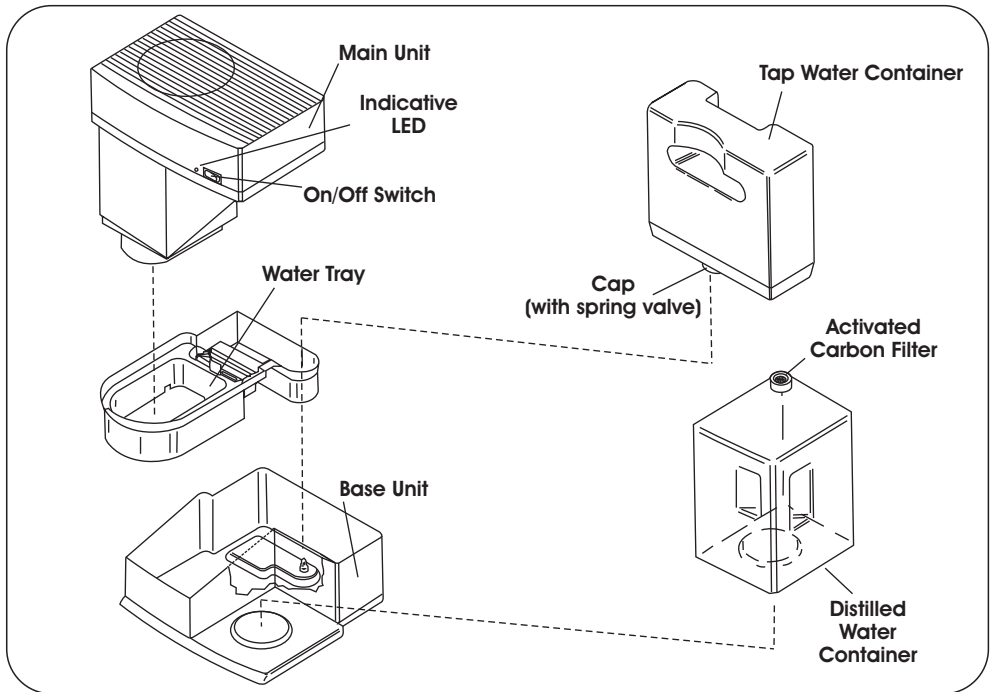

Fig. 4

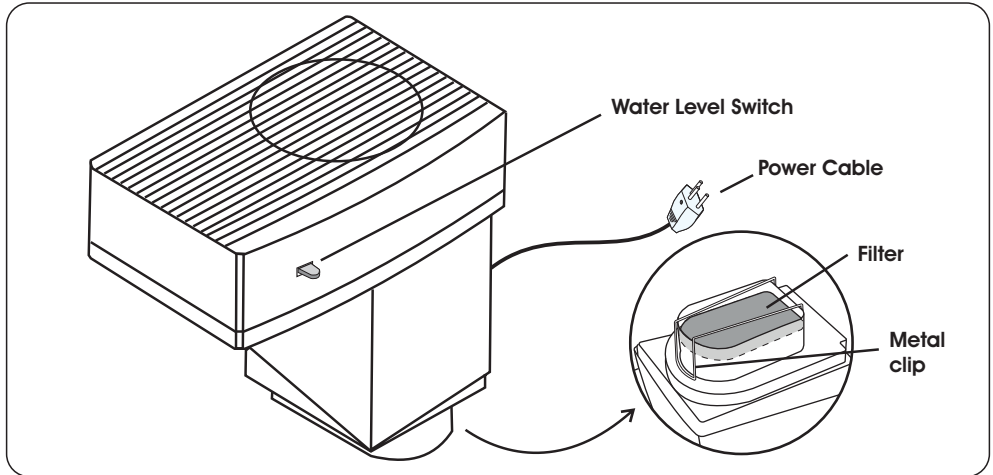

Fig. 5

HOW TO USE THE CRISTÓFOLI DISTILLER

1. Make sure the distilled water container is fitted on the base unit, without the cap.
2. Take the tap water container, remove its cap and fill it up with regular tap water (potable water provided by the public water system) or filtered water, put the cap back on the container and fit it on the base unit. The use of filtered water reduces the formation of scales (mineral crusts) on the heating element and makes maintenance easier.
3. Allow at least one minute so the water fills the tray. Plug the distiller into the electric outlet and press "ON-Reset" on the on/off switch. At this moment, if the indicative LED is on, it means that one of the following situations is happening:
 - A. The tap water container is not properly fitted on the base unit, adjust it;
 - B. The water tray is not completely filled with water. Switch it to "OFF", wait for the indicative LED to go out and switch back to the "ON-Reset" position.
4. When the cooler starts, the distiller will initiate heating. It will take from 3 to 5 minutes for the distiller to begin producing distilled water.
5. When the tap water container empties out, the distiller will shut off automatically and the indicative LED will be lit.
6. After the distiller shuts off, press "OFF" on the "ON/OFF Switch".
7. At the end of the day, unplug the equipment.
8. After use, it is important to remove the water from the equipment and store it dry and clean.

Note: In case a power outage occurs, the distiller will have to be reset to continue operation when energy is restored. To reset the distiller, press "OFF" on the "OFF/ON-Reset" switch, wait for about 3 seconds until the indicative LED turns off, then, press "ON-Reset";

DISTILLED WATER FOR HUMAN CONSUMPTION

When indicated for human consumption (it should only be used for this purpose with a medical prescription), consider that distilled water loses minerals during the distillation process. Follow the procedure below:

- A.** Carry out the first two cycles without the activated carbon filter and discard the water or use it in steam sterilization autoclaves, air humidifiers, etc. When the distiller is used for the first time, there can be some remaining harmless matter from manufacturing, packing or shipping that could alter the taste of the water.
- B.** Before proceeding with the third cycle, clean the distilled water container, the tap water container and the water tray with water and neutral soap, rinse them well.
- C.** Get the carbon filter from the plastic bag and soak it in water for 30 seconds to rinse away any loose small particles of carbon and put it on the distilled water container opening, just like a cap and start the third distillation cycle. When the cycle is complete, remove the carbon filter, let it dry naturally and put it back into the plastic bag until you need it again.

WATER FOR STEAM STERILIZATION

The table below (from standard 11817:2023) contains the suggested values for water to be used in steam sterilization autoclaves. In some specific cases, water purification through special processes may be required. Check if the obtained parameters meet your needs.

Specification of contaminants in the water supplied to a dedicated steam generator.		
Determinant	Water for moist heat sterilization	Water for LTSF sterilization
Residue on evaporation	≤ 10 mg/l	≤ 10 mg/l
Silicate	≤ 1 mg/l	≤ 1 mg/l
Iron	≤ 0,2 mg/l	≤ 0,2 mg/l
Cadmium ¹	≤ 0,005 mg/l	≤ 0,005 mg/l
Lead ¹	≤ 0,05 mg/l	≤ 0,05 mg/l
Rest of heavy metals except iron, cadmium, lead ²	≤ 0,1 mg/l	≤ 0,1 mg/l
Chloride ³	≤ 0,5 mg/l for large steam sterilizers, ≤ 2 mg/L for small steam sterilizers	≤ 0,5 mg/l
Phosphate	≤ 0,5 mg/l	≤ 0,5 mg/l
Conductivity (at 20 °C)	≤ 5 µs/cm for large steam sterilizers, ≤ 15 µs/cm for small steam sterilizers	≤ 5 µs/cm
pH (20° C) value	5 a 7,5	5 a 7,5
Appearance	Colourless, clean, without sediment	Colourless, clean, without sediment
Water hardness (Σ ions of alkaline earth)	≤ 0,02 mmol/l	≤ 0,02 mmol/l

Table 2

Note: The use of feed water with contaminants at levels exceeding those given above can greatly shorten the working life of a sterilizer and can invalidate the manufacturer's warranty or guarantee.

¹ The limiting values meet the requirements for potable water.

² European Pharmacopoeia (EP). Monograph 8, Purified Water, Test method V.3.2.8.

³ Maximal chloride concentration in feed water influences corrosion in combination with high temperatures.

DISTILLED WATER SHELF LIFE AND STORAGE

The distilled water for human consumption (when indicated) and /or to be used in steam sterilization autoclaves is 15 days from the date it was distilled.

The storage of the distilled water must be done in a clean plastic or glass container properly closed and protected from light and heat. The storage cabinets must be easy to clean, located in a dry room with fresh air, free from odors and away from disinfectants, sterilants and/or humidity.

HOW TO IDENTIFY YOUR DISTILLER

The identification label is affixed on the bottom of the equipment.

ATTENTION - Removing the Identification Label and/or any other stickers from the product will cause automatic loss of warranty.

TECHNICAL DATA

TECHNICAL DATA CHART	CRISTÓFOLI DISTILLER
Tap Water Container Capacity	4 liters
Distilled Water Container Capacity	3,8 liters
Gross Weight (packed)	4 kg
Net Weight	3,4 kg
Cycle Total Time (full Container)	6 a 8 hours (to distill 3,8 liters of water)
Equipment Dimensions (W x H x D)	27 x 33 x 27,6 cm
Box Dimensions (L x A x P)	30,5 x 36 x 30,5 cm
Voltage	127 V or 220 V ~ single-phase
Frequency	50/60 Hz
Power & Energy Consumption (model 127 V)	550 Watts - 0,55 Kw/hours
Power & Energy Consumption (model 220 V)	450 Watts - 0,45 Kw/hours
Proper Working Temperature	15 °C to 40 °C
ANVISA Register	Exempt

Table 3

PREVENTIVE MAINTENANCE

Some procedures are necessary for the best functioning and durability of your equipment. The preventive maintenance corresponds to the **fulfilment of all procedures listed below**, that must be done periodically, by the consumer's costs.

Certify that the distiller is not hot before touching or handling it. Wait for at least 30 minutes for cooling after unplugging the equipment.

Make sure the equipment is unplugged before performing any kind of maintenance, including cleaning.

PERIODICITY	MAINTENANCE
DAILY	<p>External cleaning:</p> <p>Unplug the equipment. Use a cloth dampened with biodegradable neutral detergent, next, clean it with another cloth dampened with alcohol 70% or peracetic acid at 1%, make smooth movements in one direction only.</p>
EVERY 6 CYCLES	<p>Water tray, filter and heating element cleaning:</p> <p>The water tray is removable, it can be washed manually or put into the dishwasher.</p> <p>Remove the clip and the filter, next, wash it in running water and set it aside until you assemble the equipment again.</p> <p>Fill the water tray with white vinegar, let it rest for at least 3 hours. The cleaning solution will soften the scale deposits.</p> <p>After that, remove the main unit and the water tray, wash the heating element with a brush with soft bristles, next, wash the water tray and rinse it. Finish the cleaning procedure with a soft cloth that does not shed.</p>
EVERY 2 MONTHS	<p>Activated carbon filter replacement:</p> <p>Depending on the frequency of distillation cycles intended for human consumption, the replacement may be anticipated. Additional filters may be purchased at the Cristófoli Authorized Technical Assistance.</p>
EVERY 3 MONTHS	<p>Heating element filter replacement:</p> <p>Depending on the quality of the water, the replacement may be anticipated. Additional filters may be purchased at the Cristófoli Authorized Technical Assistance.</p>

Table 4

TROUBLESHOOTING

For any replacement of parts, contact your local retailer or an authorized Cristófoli representative. It's strongly not recommended the replacement of any parts by non-qualified people.

We have listed below the most frequent problems and possible solutions the operator can try in his/her own office.

THE DISTILLER DOES NOT TURN ON

POSSIBLE CAUSES	SOLUTIONS
• The distiller is not plugged in -----	• Plug the distiller into the electric outlet;.
• No power -----	• Check if there is a power outage in your building.
• Defective power cable -----	• See "Authorized Technical Assistance" (Page 12).

O DESTILADOR LIGA, MAS NÃO AQUECE

POSSIBLE CAUSES	SOLUTIONS
• The heating element or thermal fuse has burned out -----	• See "Authorized Technical Assistance" (Page 12).

If the problem persists after the verification of all the items listed, contact your local retailer or an authorized Cristófoli representative.

QUALITY CONTROL

Cristófoli Distillers are tested on a batch sample basis, according to the parameters of the table below.

Heating Time	Distillation Time
Cold distiller 3 to 5 minutes	6 to 8 hours for 3,8 liters (average of 600 ml/hour)

Table 5

AUTHORIZED TECHNICAL ASSISTANCE

If there's any problem with your equipment, first, take a look at the topic "*Troubleshooting*" (Page 11), in case the problem persists, get in touch with your local retailer or an authorized Cristófoli representative to schedule an evaluation or repair of your equipment.

Before making contact, please have in hands the model of your equipment, voltage, serial number and the date of manufacture found on the identification label located on the bottom of the equipment and a description of the problem.

GUIDANCE FOR FINAL DISPOSAL OF THE EQUIPMENT

The environment is something that belongs to everyone, therefore, it is up to each one of us to make the decisions that will help in its preservation and reduction of the damages resulting from human activities.

All products have a useful life span, but it is not possible to determine how long, as it varies according to the intensity and how the equipment is used or handled.

Cristófoli Equipamentos de Biossegurança Ltda., makes clear its concern, strongly recommends users of their products to seek the best destination when disposing your equipment or its components, taking into account the materials recycling legislation effective in your country.

We advise you to take your equipment to specialized recycling companies that, due to the continuous and fast paced development of new recycling technologies and materials reuse, provide the best way of disposing the equipment. Cristófoli contributes this way to reduce the consumption of non-renewable raw materials.

On behalf of all users, we thank you for your comprehension and cooperation.

WARRANTY TERMS

CRISTÓFOLI EQUIPAMENTOS DE BIOSSEGURANÇA LTDA., warrants the Cristófoli Distillers for 01 (one) year against any manufacturing defect from the date of the purchase receipt (provided it contains the serial and lot numbers of the equipment), of which 03 (three) months refer to the legal warranty (established by section II, art. 26, CDC, Brasil) and nine (09) months to the contractual warranty (arranged in art. 50, CDC, Brasil).

Traveling costs (based on the distance traveled in km) and the stay of the authorized technician for installation, repair or maintenance **(preventive or corrective) before or after the warranty period** will be responsibility of the buyer/owner as well as costs related to preventive maintenance and freight charges for shipping the equipment to the authorized technical assistance office for repairs or if necessary.

The warranty will be voided in cases of:

- Problems arising from natural causes (such as floods, lightning, etc.).
- Sinister (theft or robbery).
- Damage caused by accidents, such as: drops, failure of the power supply and/or building wiring, short circuits, fire, etc..
- Improper installation of the equipment and/or plugging it into an incorrect voltage outlet.
- Removal and/or tempering of the serial number shown in the identification label of the product
- Signs of tampering and/or blotted out data on the purchase or service receipt of the equipment.
- Signs of external violation of the product or broken factory seal.
- Use of accessories and/or materials not specified by Cristófoli.
- Changes made to the equipment by the client himself/herself.
- Repairs performed by technicians who are not part of the Cristófoli Authorized Service Network.
- Noncompliance with any measure or caution recommended in the instruction manual of the product.
- Lack of grounding or grounding not in accordance with the current standards of the country.
- Problems caused by the absence of preventive maintenance when it is essential.

The plastic containers, heating element filter and activated carbon filters are not covered by the warranty

